

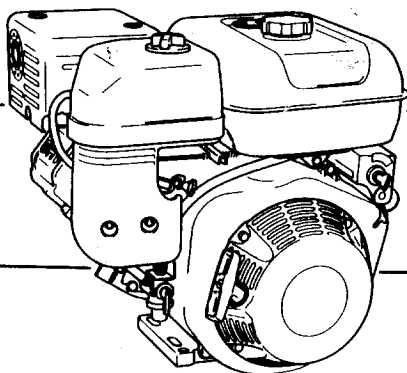

MODEL

EH36D/36B
EH41D/41B

INSTRUCTIONS FOR USE
FOR EMISSION CERTIFIED ENGINE



ISSUE EMD-EU1211

2ZZ9020069

Robin Engines

NOTICE

The FEDERAL EMISSION COMPONENT DEFECT WARRANTY and CALIFORNIA EMISSION CONTROL WARRANTY stated in the beginning of this manual are only applicable to the engines sold and used in respective States in the U.S.A.

To the engines exported to and used in the countries other than the U.S.A., warranty service shall be performed by the distributor in each country in accordance with the standard Robin engine warranty policy as applicable.



WARNING:



The engine exhaust from this product contains chemicals known to the State of California to cause cancer, birth defects or other reproductive harm.

FEDERAL EMISSION COMPONENT DEFECT WARRANTY

EMISSION COMPONENT DEFECT WARRANTY COVERAGE - This emission warranty is applicable in all States, except the State of California

Fuji Heavy Industries Ltd. and Robin America Inc., Wood Dale Illinois, (herein "ROBIN AMERICA") warrant to the initial retail purchaser and each subsequent owner, that this utility equipment engine (herein "engine") has been designed, built, and equipped to conform at the time of initial sale to all applicable regulations of the U.S. Environmental Protection Agency (EPA), and that the engine is free of defects in materials and workmanship which would cause this engine to fail to conform with EPA regulations during its warranty period.

For the components listed under **PARTS COVERED**, the dealer or service center authorized by ROBIN AMERICA will, at no cost to you, make the necessary diagnosis, repair, or replacement necessary to ensure that the engine complies with applicable U.S. EPA regulations.

EMISSION COMPONENT DEFECT WARRANTY PERIOD

The warranty period for this engine begins on the date of sale to the initial purchaser and continues for a period of 2 years.

PARTS COVERED

Listed below are the parts covered by the Emission Component Defect Warranty. Some of the parts listed below may require scheduled maintenance and are warranted up to the first scheduled replacement point for that part.

- | | |
|------------------------------------|--|
| 1) Fuel Metering System | 3) Ignition System |
| (i) Carburetor and internal parts | (i) Spark plug |
| (ii) Choke System | (ii) Magneto |
| (iii) Fuel strainer, if applicable | 4) Exhaust pipe, if applicable |
| 2) Air Induction System | 5) Miscellaneous Items Used in Above Systems |
| (i) Air filter element | (i) Fuel hoses, clamps and sealing gaskets |
| (ii) Intake pipe, if applicable | |

OBTAINING WARRANTY SERVICE

To obtain warranty service, take your engine to the nearest Authorized Robin America, Inc., distributor or dealer. Bring your sales receipts indicating date of purchase for this engine.

The dealer or service center authorized by ROBIN AMERICA, will perform the necessary repairs or adjustments within a reasonable amount of time and furnish you with a copy of the repair order.

All parts and accessories replaced under this warranty become the property of ROBIN AMERICA.

WHAT IS NOT COVERED

- * Conditions resulting from tampering, misuse, improper adjustment (unless they were made by the dealer or service center authorized by ROBIN AMERICA during a warranty repair), alteration, accident, failure to use the recommended fuel and oil, or not performing required maintenance services.
- * The replacement parts used for required maintenance services.
- * Consequential damages such as loss of time, inconvenience, loss of use of the engine of equipment, etc.

- * Diagnosis and inspection charges that do not result in warranty-eligible service being performed.
- * Any non-authorized replacement part, or malfunction of authorized parts due to use of non-authorized parts.

OWNER'S WARRANTY RESPONSIBILITIES

As the engine owner, you are responsible for the performance of the required maintenance listed in your owner's manual. ROBIN AMERICA recommends that you retain all receipts covering maintenance on your engine, but Robin America can not deny warranty solely for the lack of receipts or for your failure to ensure the performance of all scheduled maintenance.

As the engine owner, you should however be aware that the ROBIN AMERICA may deny your warranty coverage if your engine or a part has failed due to abuse, neglect, improper maintenance or unapproved modifications.

You are responsible for presenting your engine to the nearest dealer or service center authorized by ROBIN AMERICA when a problem exists.

If you have any questions regarding your warranty rights and responsibilities, you should contact the Robin America Inc. Customer service department at 1-630-350-8200 for the information.

THINGS YOU SHOULD KNOW ABOUT THE EMISSION CONTROL SYSTEM WARRANTY MAINTENANCE AND REPAIRS

You are responsible for the proper use and maintenance of the engine. You should keep all receipts and maintenance records covering the performance of regular maintenance in the event questions arise. These receipts and maintenance records should be transferred to each subsequent owner of the engine. ROBIN AMERICA reserves the rights to deny warranty coverage if the engine has not been properly maintained. Warranty claims will not be denied, however, solely because of the lack of required maintenance or failure to keep maintenance records.

MAINTENANCE, REPLACEMENT OR REPAIR OF EMISSION CONTROL DEVICES AND SYSTEMS MAY BE PERFORMED BY ANY REPAIR ESTABLISHMENT OR INDIVIDUAL ; HOWEVER, WARRANTY REPAIRS MUST BE PERFORMED BY A DEALER OR SERVICE CENTER AUTHORIZED BY ROBIN AMERICA. THE USE OF PARTS THAT ARE NOT EQUIVALENT IN PERFORMANCE AND DURABILITY TO AUTHORIZED PARTS MAY IMPAIR THE EFFECTIVENESS OF THE EMISSION CONTROL SYSTEM AND MAY HAVE A BEARING ON THE OUTCOME OF A WARRANTY CLAIM.

If other than the parts authorized by ROBIN AMERICA are used for maintenance replacements or for the repair of components affecting emission control, you should assure yourself that such parts are warranted by their manufacturer to be equivalent to the parts authorized by ROBIN AMERICA in their performance and durability.

HOW TO MAKE A CLAIM

All repairs qualifying under this limited warranty must be performed by a dealer or service center authorized by ROBIN AMERICA. In the event that any emission-related part is found to be defective during the warranty period, you shall notify ROBIN AMERICA customer service department at 1-630-350-8200 and you will be given the appropriate warranty service facilities where the warranty repair can be performed.

Emission Control System Warranty Statement

CALIFORNIA EMISSION CONTROL WARRANTY STATEMENT

YOUR WARRANTY RIGHTS AND OBLIGATIONS

The California Air Resources Board and Fuji Heavy Industries Ltd. (herein "FUJI") are pleased to explain the emission control system warranty on your 1997 and later utility and lawn and garden equipment engine (herein "engine"). In California, the engine must be designed, built and equipped to meet the State's stringent anti-smog standards. FUJI must warrant the emission control system on your engine for the periods of time described below, provided there has been no abuse, neglect or improper maintenance of your engine.

Your emission control system may include parts such as the carburetor and the ignition system. Also included may be hoses, connectors and other emission-related assemblies.

Where a warrantable condition exists, FUJI will repair your engine at no cost to you including diagnosis, parts and labor.

MANUFACTURER'S WARRANTY COVERAGE :

The 1997 and later engines are warranted for two (2) years. If any emission related part on your engine is defective, the part will be repaired or replaced by FUJI.

OWNER'S WARRANTY RESPONSIBILITIES :

-As the engine owner, you are responsible for the performance of the required maintenance listed in your Owner's Manual. FUJI recommends that you retain all receipts covering maintenance on your engine, but FUJI cannot deny warranty solely for the lack of receipts or for your failure to ensure the performance of all scheduled maintenance.

-As the engine owner, you should, however, be aware that FUJI may deny you warranty coverage if your engine or a part has failed due to abuse, neglect, improper maintenance or unapproved modifications.

-You are responsible for presenting your engine to a dealer, distributor or warranty station authorized by ROBIN AMERICA Inc., 940 Lively Blvd., Wood Dale, IL60191 (herein "ROBIN AMERICA") as soon as a problem exists. The warranty repairs should be completed in a reasonable amount of time, not to exceed 30 days.

If you have any questions regarding your warranty rights and responsibilities, you should contact the ROBIN AMERICA Inc. customer service manager at 630-350-8200.

LIMITED WARRANTY
on Emission Control Systems
— California Only —

FUJI, Tokyo, Japan warrants to the owner of the 1997 and later engine that the engine (1) has been designed, built and equipped so as to conform at the time of manufacture with the applicable regulations of the California Air Resources Board, and (2) is free from defects in materials and workmanship which could cause it to fail to conform with those regulations as may be applicable in the terms and conditions stated below.

A. COMMENCEMENT DATE

The warranty period begins on the date the engine is delivered to a first retail purchaser.

B. LENGTH OF COVERAGE

FUJI warrants to a first retail purchaser and each subsequent purchaser that the engine is free from defects in materials and workmanship which cause the failure of a warranted emission-related part for a period of two (2) years after the date of delivery to the first retail purchaser.

C. WHAT IS COVERED :

1. REPAIR OR REPLACEMENT PARTS

Repairs and replacement of any warranted part will be performed at no charge to you by an authorized dealer, distributor or a warranty station. You may contact the ROBIN AMERICA Inc. customer service manager at 630-350-8200 to get the nearest appropriate location where your warranty repairs are performed.

2. WARRANTY PERIOD

This warranty continues for a period of two (2) years and shall apply only to the repair, replacement or adjustment of the component parts which are not scheduled for replacement as required maintenance. Further, component parts which are scheduled only for regular inspection to the effect of "repair or replace as necessary" shall be warranted for the warranty period. Any warranted part which is scheduled for replacement as required maintenance shall be warranted for the period of time up to the first scheduled replacement point for that part.

3. DIAGNOSIS

You shall not be charged for diagnostic labor which leads to the determination that a warranted part is defective, if the diagnostic work is performed at an authorized dealer, distributor or warranty station.

4. DAMAGES

If a warranted part failed causing damage to other engine components, consult a warranty station.

D. WHAT IS NOT COVERED

1. This limited warranty does not cover any part which malfunctions, fails or is damaged due to failure to follow the maintenance and operating instructions set forth in the 1997 and later Owner's Manual including :

- (1) improper or inadequate maintenance of any warranted parts
- (2) improper installation, adjustment or repair of the engine or of any warranted part unless performed by an authorized dealer
- (3) failure to follow recommendations on fuel use contained in the 1997 and later Owner's Manual
- (4) repairs performed outside of the authorized warranty service facilities
- (5) use of parts which are not authorized by FUJI

2. Add-on or modified parts

This warranty does not cover any part which malfunctions, fails or is damaged due to alterations by changing, adding to or removing parts from the engine.

3. Expenses incurred by processing warranty claims

FUJI, any authorized dealer, distributors and warranty station shall not be liable for any loss of use of the engine, for any alternative usage, for any damage to goods, loss of time or inconvenience.

E. HOW TO FILE A CLAIM

All repairs qualifying under this Limited Warranty must be performed by a dealer who sold you the engine or distributors or warranty stations authorized by ROBIN AMERICA. In the event that any emission-related part is found to be defective during the warranty period, you shall notify ROBIN AMERICA Inc. customer service manager at 630-350-8200 and you will be given the appropriate warranty service facilities where the warranty repair is performed.

F. WHERE TO GET WARRANTY SERVICE

It is recommended that warranty service be performed by the authorized dealer who sold you the engine, although warranty service will be performed by any authorized dealers, distributors and warranty stations anywhere in the United States. When warranty repair is needed, the engine must be brought to an authorized dealer, distributorship or warranty station's place of business during normal business hours. In all cases, a reasonable time, not to exceed 30 days, must be allowed for the warranty repair to be completed after the engine is received by the authorized dealer, distributor or service station.

G. MAINTENANCE, REPLACEMENT AND REPAIR OF EMISSION-RELATED PARTS

Only warranted engine replacement parts approved by FUJI should be used in the performance of any warranty maintenance or repairs on emission-related parts. If other than authorized parts are used for maintenance, replacement or repair of components affecting emission control, you should assure yourself that such parts are warranted by their manufacturer to be equivalent to authorized parts in performance and durability. FUJI, however, assumes no liability under this warranty with respect to parts other than authorized parts. The use of non-authorized replacement parts does not invalidate the warranty on other components unless the non-authorized parts cause damage to warranted parts.

H. PARTS COVERED UNDER THE CALIFORNIA EMISSIONS WARRANTY

- 1) Fuel Metering system
 - (i) Carburetor and internal parts
 - (ii) Choke System
 - (iii) Fuel strainer, if applicable
- 2) Air Induction System
 - (i) Intake pipe, if applicable
 - (ii) Air filter element
- 3) Ignition System
 - (i) Spark plug
 - (ii) Magneto
- 4) Exhaust pipe, if applicable
- 5) Miscellaneous Items Used in Above Systems
 - (i) Fuel hoses, clamps and sealing gaskets

I. MAINTENANCE STATEMENTS











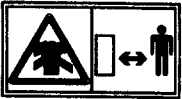

It is your responsibility to have all scheduled inspection and maintenance services performed at the times recommended in the 1998 and later Owner's Manual and to retain proof that inspection and maintenance services are performed at the times when recommended. FUJI will not deny a warranty claim solely because you have no record of maintenance ; however, FUJI may deny a warranty claim if your failure to perform required maintenance resulted in the failure of warranted part. The proof which you maintain should be given to each subsequent owner of the engine. You are responsible for performing the scheduled maintenance described below based on the procedures specified in the 1998 and later Owner's Manual. The scheduled maintenance below is based on the normal engine operating schedule.

<u>PROCEDURE</u>	<u>INTERVAL</u>
1) Clean engine and check bolts & nuts	: Every 8 hours (daily)
2) Check and refill engine oil	: Every 8 hours (refill daily up to upper limit)
3) Change engine oil	: Initial 20 hours and every 50 hours afterward
4) Clean spark plug	: Every 50 hours (weekly)
5) Clean air cleaner	: Every 50 hours
6) Clean fuel strainer	: Every 200 hours (Monthly)
7) Clean and adjust spark plug and electrodes	: Every 200 hours (Monthly)
8) Clean carburetor	: Every 500 hours
9) Clean cylinder head	: Every 500 hours
10) Adjust valve clearance	: Every 500 hours
11) Replace spark plug	: Every 500 hours
12) Replace fuel lines	: Every 1000 hours (Yearly)
13) Overhaul engine if necessary	: Every 1000 hours

CONTENTS

1. SAFETY PRECAUTIONS	1
2. COMPONENTS	4
3. PRE-OPERATION CHECKS	5
4. ELECTRIC STARTER MODELS	6
5. OPERATING YOUR ENGINE	8
6. EASY TROUBLESHOOTING	12
7. OIL SENSOR INSTRUCTIONS (OPTIONAL)	14
8. MAINTENANCE SCHEDULE	15
9. "HOW-TO" MAINTENANCE	17
10. PREPARATIONS FOR STORAGE	20
11. SPECIFICATIONS	21

SYMBOLS

	<p>Read the owner's manual.</p>		
	<p>Stay clear of the hot surface.</p>		
	<p>Exhaust gas is poisonous. Do not operate in an unventilated area.</p>		
	<p>Stop the engine before refueling.</p>		
	<p>Fire, open flame and smoking prohibited.</p>		
	<p>On (Run)</p>		<p>Plus; Positive polarity</p>
	<p>Off (Stop)</p>		<p>Battery</p>
	<p>Engine oil</p>		<p>Engine start (Electric start)</p>
	<p>Add oil</p>		

1. SAFETY PRECAUTIONS

Please make sure you review each precaution carefully.

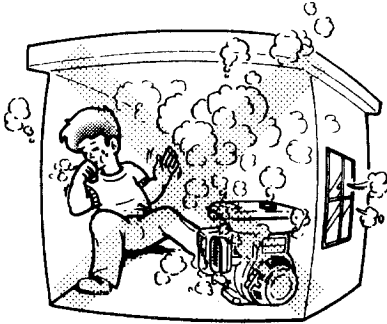

EXHAUST PRECAUTIONS

- Never inhale exhaust gasses. They contain carbon monoxide, a colorless, odorless and extremely dangerous gas which can cause unconsciousness or death.
- Never operate the engine indoors or in a poorly ventilated area, such as tunnel, cave, etc.
- Exercise extreme care when operating the engine near people or animals.
- Keep the exhaust pipe free of foreign objects.

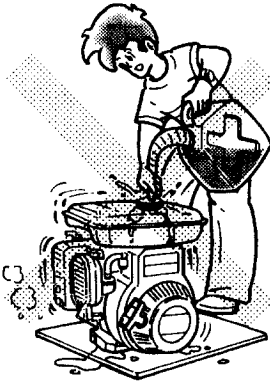

REFUELING PRECAUTIONS

- Be sure to stop the engine prior to refueling.
- Do not overfill the fuel tank.
- If fuel is spilt, wipe it away carefully and wait until the fuel has dried before starting the engine.
- After refueling, make sure that the fuel cap is secured to prevent spillage.



FIRE PREVENTION

- Do not operate while smoking or near an open flame.
- Do not use around dry brush, twigs, cloth rags, or other flammable materials.
- Keep the engine at least 3 feet (1 meter) away from buildings or other structures.
- Keep the engine away from flammables and other hazardous materials (trash, rags, lubricants, explosives).

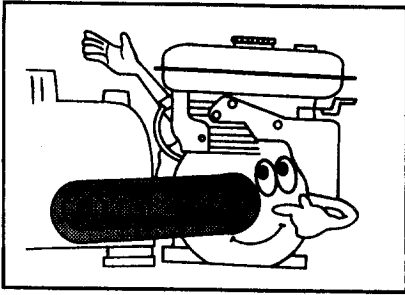

PROTECTIVE COVER

- **Place the protective covers over the rotating parts.**

If rotating parts such as the drive shaft, pulley, belt, etc. are left exposed, they are potentially hazardous. To prevent injury, equip them with protective covers or shrouds.

- **Be careful of hot parts.**

The muffler and other engine parts become very hot while the engine is running or just after it has stopped.

Operate the engine in a safe area and keep children away from the running engine.

- **Never make adjustments on the machinery while it is connected to the engine, without first removing the ignition cable from the spark plug.**

Turning the crankshaft by hand during adjusting or cleaning might start the engine, and machinery with it, causing serious injury to the operator.

- **Never run the engine with governor disconnected, or operate at speeds in excess of 3600 rpm load.**

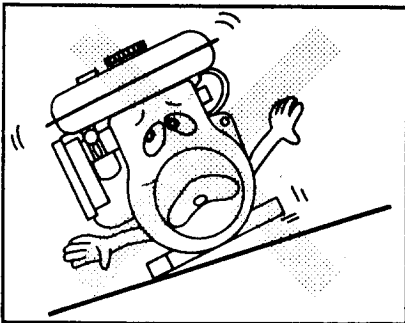

SURROUNDINGS

- **Operate the engine on a stable, level surface free of small rocks, loose gravel, etc.**
- **Operate the engine on a level surface.**

If the engine is tilted, fuel spillage may result.

NOTE

Operating the engine at a steep incline may cause seizure due to improper lubrication even with a maximum oil level.



- **Be careful of fuel spillage when transporting the engine.**

Tighten the fuel tank cap securely and close the fuel strainer cock before transport.

- **Do not move the engine while in operation when it has been removed from the equipment.**

- **Keep the unit dry (do not operate it in rainy conditions).**

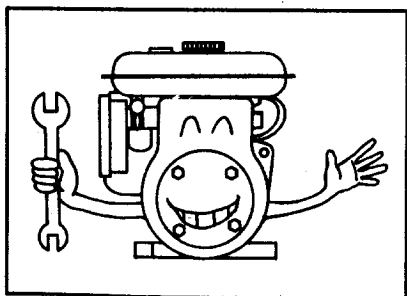

PRE-OPERATION CHECKS

- **Carefully check fuel hoses and joints for looseness and fuel leakage.**

Leaked fuel creates a potentially dangerous situation.

- **Check bolts and nuts for looseness.**

A loose bolt or nut may cause serious engine trouble.

- **Check the engine oil and refill if necessary.**

- **Check the fuel level and refill if necessary.**

Take care not to overfill the tank.

- **Wear snug fitting working clothes when operating the engine.**

Loose aprons, towels, belt, etc., may be caught in the engine or drive train, causing a dangerous situation.

2. COMPONENTS

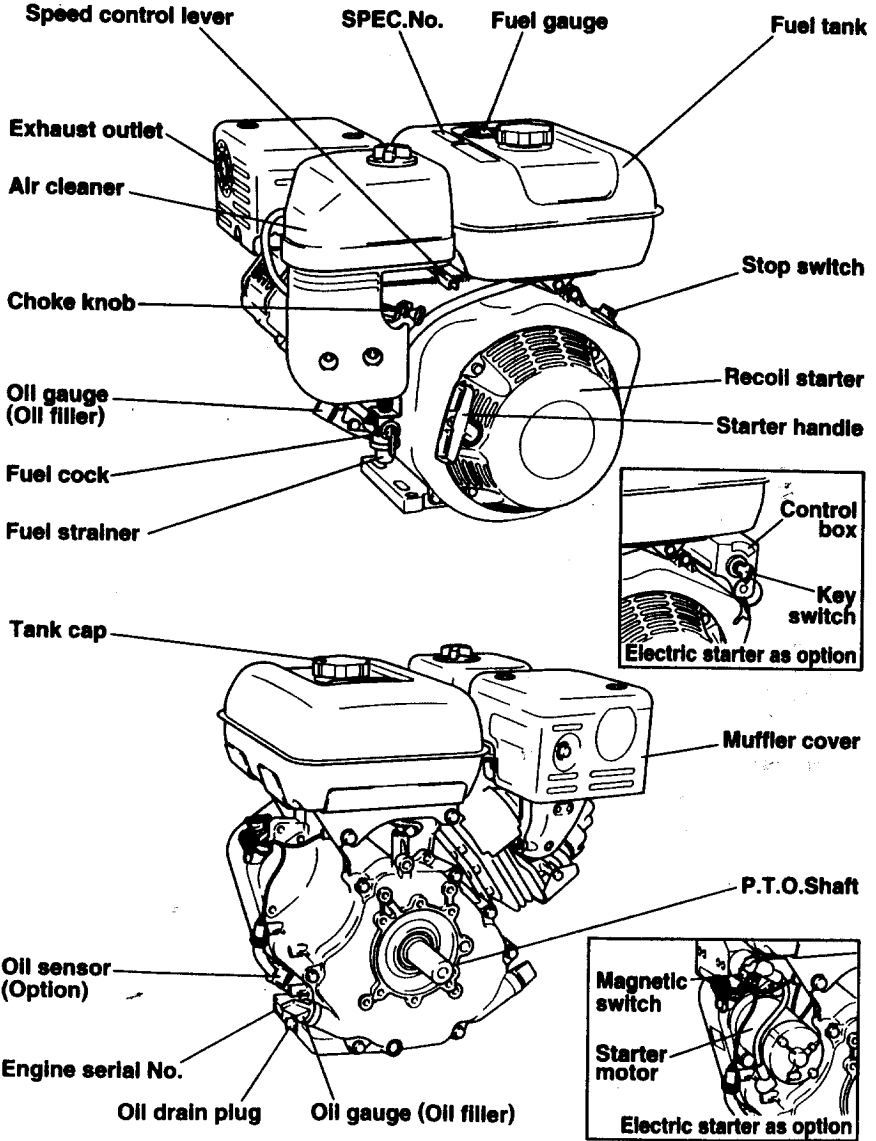

3. PRE-OPERATION CHECKS

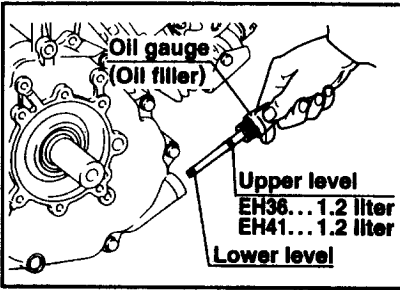

Single grade	5W						
	10W						
	20W						
	#20						
	#30						
Multi grade	10W-30						
	10W-40						
Ambient temperature	-20	-10	0	10	20	30	40°C
	-4	14	32	50	68	86	104°F



CHECK ENGINE OIL

Before checking or refilling engine oil, be sure the engine is located on a stable, level surface and stopped.

- Do not thread the gauge into oil filler to check oil level.
- If the oil level is below the lower level line on the dipstick, refill with the proper oil (see table) to the upper level.
- Change oil if it is contaminated. (See page 15 Maintenance Schedule.)
- Use class SE,SF (API classification) or higher grade oil.
- If multi-grade oil is employed, oil consumption tends to increase when the ambient temperature is high.

CHECK FUEL

CAUTION

Do not refuel while smoking, near an open flame or other potential hazards.

- Stop the engine and open the cap.
- Use unleaded gasoline only.
- Close the fuel cock before filling the fuel tank.
- When filling the fuel tank, always use the fuel filter.
- Wipe off any spilled fuel before starting the engine.

4. ELECTRIC STARTER MODELS

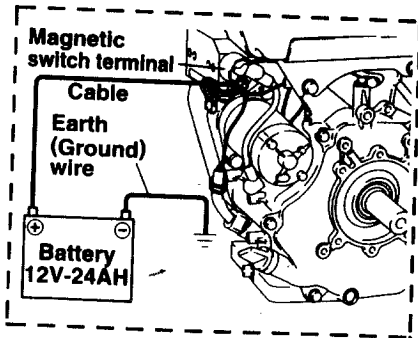
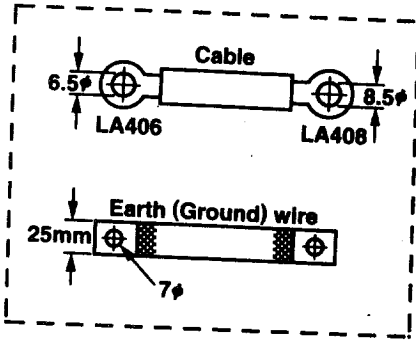

PARTS TO BE PREPARED

- Use a battery rated 12V-24AH or larger.
- Use a proper cable and ground wire to connect battery.

BATTERY

CABLE LENGTH	CABLE DIA.	WIRE GAUGE		
		AWG(BS) BWG	SAE	JIS
Less than 1.5m	7.3mm	1	6	AV15
1.5m to 2.5m	8.5mm	0	4	AV20
2.5m to 4m	10.8mm	3/0	2	AV30

For GROUND WIRE, use a flat braided wire of 0.03 sq. in. or larger sectional area. (SAE GAUGE #4)

WIRING

1. Connect positive terminal on magnetic switch and positive terminal of the battery with battery cable.
2. Ground negative terminal of the battery to the body of engine or machine with earth (ground) wire.
3. When installing the key switch on the machine, install with its drain hole at the bottom.

NOTE

Tighten bolts and nuts on terminals securely so they will not be loosened by vibration.

WIRING DIAGRAM

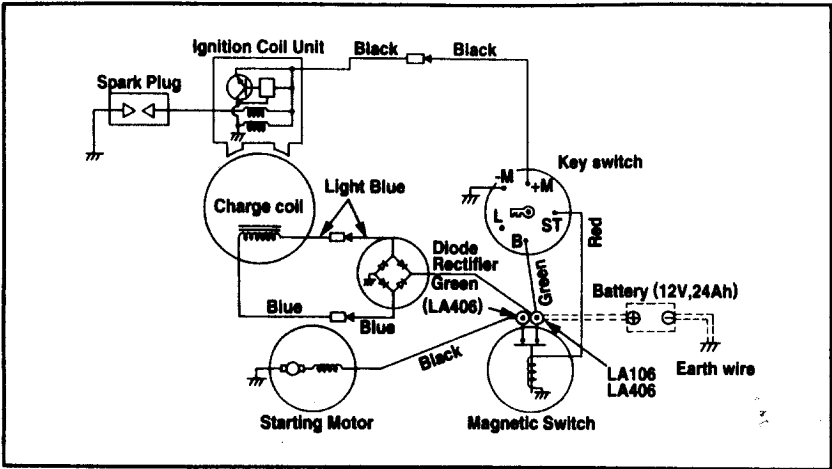

SWITCH CABLE

If a remote key switch is used, select wires of proper gauge to connect it and magnetic switch of the engine.

CABLE LENGTH	CABLE DIA.	WIRE GAUGE		
		AWG(BS)	BWG	JIS
Less than 1.5m	1.5 mm	14	16	AV1.25
1.5 - 3m	1.9 mm	12	14	AV2
3 - 5m	2.4 mm	10	13	AV3

5. OPERATING YOUR ENGINE

STARTING

STOP SWITCH

1

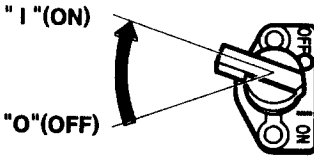

Turn the STOP SWITCH clockwise to the position "I" (ON).

FUEL COCK

2

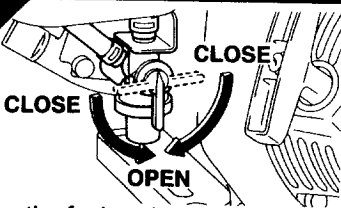

Open the fuel cock.

SPEED CONTROL LEVER

3

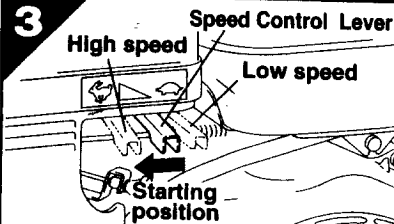

Set the speed control lever 1/3 to 1/2 of the way towards the high speed position.

CHOKE KNOB

4

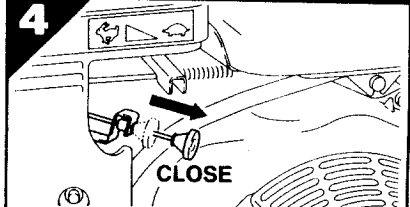

Close the choke knob.

- If the engine is warm or the ambient temperature is high, open the choke knob half-way, or keep it fully open.
- If the engine is cold or the ambient temperature is low, close the choke knob fully.

RECOIL STARTER

5

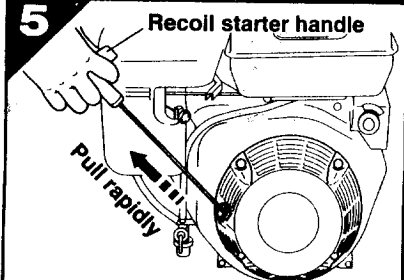

- Pull the starter handle slowly until resistance is felt. This is the "compression" point. Return the handle to its original position and pull swiftly.
- Do not pull out the rope all the way.
- After starting the engine, allow the starter handle to return to its original position while still holding the handle.

RUNNING

KEY SWITCH (OPTIONAL)

5



Insert the key into the key slot and set it at the "I" (ON) position. Turning it to the right (START position) starts the engine.

- Do not operate the electric starter continuously for more than 5 seconds, even if the engine does not start.
- If the engine failed to start, set the key to the "I" (ON) position and wait for about 10 seconds before retrying.
- Never turn the key switch to the START position while engine is running.

CHOKE KNOB

6

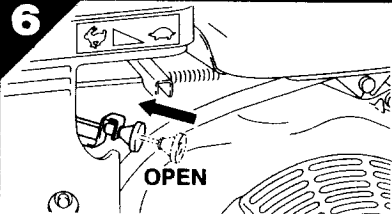

- After starting the engine, gradually open choke by turning the choke knob and finally keep it fully opened.
- Do not fully open the choke knob immediately when the engine is cold or the ambient temperature is low, because the engine may stop.

SPEED CONTROL LEVER

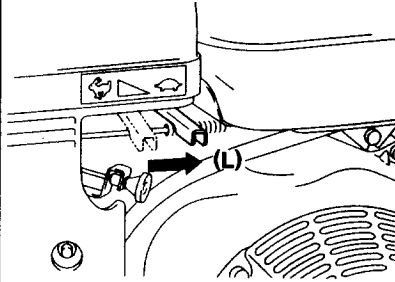

After the engine starts, set the speed control lever at the low speed position (L) and warm it up without load for a few minutes.

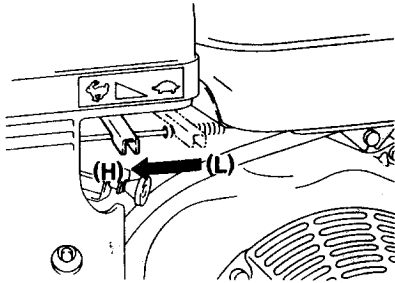

Gradually move the speed control lever toward the high speed position (H) and set it at the required engine speed.

NOTE :

Whenever high speed operation is not required, slow the engine down (idle) by moving the speed control lever to save fuel and extend engine life.

STOPPING

SPEED CONTROL LEVER

1

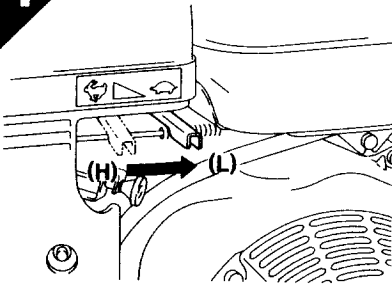

Set the speed control lever at the low speed position and allow the engine to run at low speed for 2 or 3 minutes before stopping.

STOP SWITCH

2

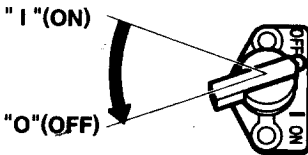

Turn the STOP SWITCH counter-clockwise to the position "O" (OFF).

KEY SWITCH (OPTIONAL)

2



Set the key switch to "O" (STOP) position.

FUEL COCK

3

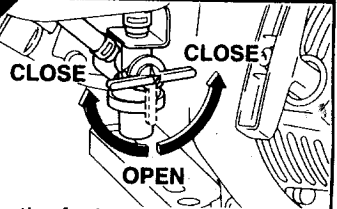

Close the fuel cock.

RECOIL STARTER

4

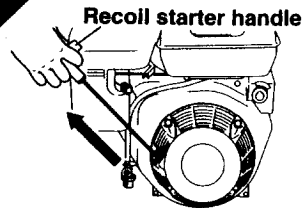

Pull the starter handle slowly and return the handle to its original position when resistance is felt.

NOTE :

The above operation is necessary to prevent outside moist air from intruding into the combustion chamber.

STOPPING ENGINE WITH THE FUEL COCK

Close the fuel cock and wait for a while until the engine stops.

Avoid to let the fuel remain in the carburetor over long periods, or the passages of the carburetor may become clogged with impurities, and malfunctions may result.

If your engine has an electric starter, set the key switch to the "O" (STOP) position after stopping the engine.

6. EASY TROUBLESHOOTING

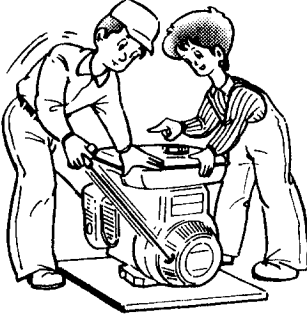

WHEN ENGINE WILL NOT START :

- Perform the following checks before you take the engine to your Robin dealer.
- If you still have trouble after completing the checks, take the engine to your nearest Robin dealer.



Is there enough compression ?

1. Pull the starter handle slowly and check if resistance is felt.
2. If little force is required to pull the starter handle, check if the spark plug is tightened firmly.
3. If the spark plug is loose, tighten it.

Is the spark plug wet with gasoline ?

1. Choke (close choke lever) and pull the starter handle five or six times. Remove the plug and check if its electrode is wet. If the electrode is wet, fuel is well supplied to your engine.
2. When the electrode is dry, check where the fuel stops. (Check the fuel intake of the carburetor and fuel strainer intake.)
3. In case the engine does not start with well supplied fuel, try using fresh fuel.

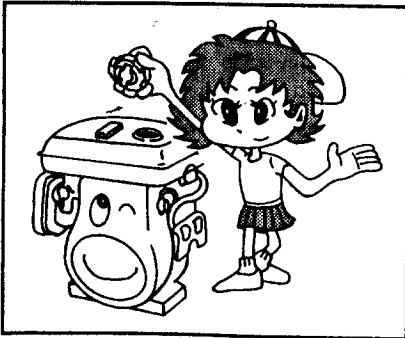

Is there a strong spark across the electrode?

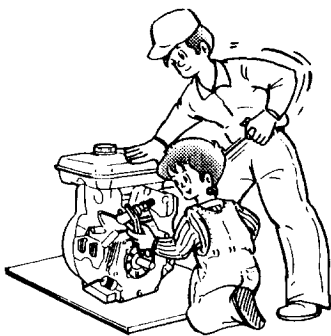

⚠ WARNING

- Wipe out spilled fuel carefully before testing. Place spark plug as far away from spark plug hole as possible.
- Do not hold spark plug by hand while pulling recoil starter.

1. Remove the spark plug and connect it to the plug cap.
Pull the starter handle while grounding spark plug against engine body.
2. Try with a new spark plug if the spark is weak or there is no spark.
3. The ignition system is faulty if there is no spark with a new spark plug.
Take your engine to your nearest Robin dealer.

NOTE

The engine with oil sensor will stop automatically when the oil level falls below the prescribed limit.
The engine can not be started unless the oil level is raised above the prescribed limit.



Is your battery well charged?

If your battery for the electric starter is overly discharged, your engine will not start.

Consult your nearest dealer or service shop.

7. OIL SENSOR INSTRUCTIONS (OPTIONAL)

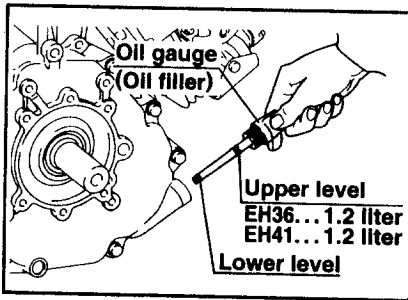

Is your oil sensor OK ?

The engine will stop automatically when the oil level falls below the safety limit. The engine cannot be started unless the level is raised above the prescribed limit.

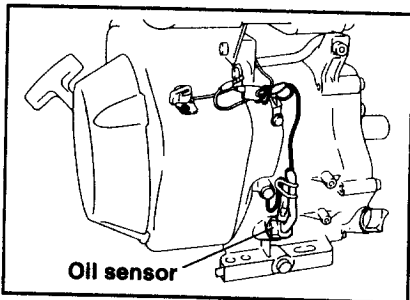

RESTARTING

- Fill the crankcase with oil up to the proper level.
- As for restarting and operating the engine, refer to Section 5, "OPERATING YOUR ENGINE" on page 8.
- Check the wire connector from the engine. It must be connected securely to the wire from oil sensor.

NOTE

- Do not remove the oil sensor from the engine for checking oil level and refilling.
- When selecting the engine oil, refer to the chart on page 5.

8. MAINTENANCE SCHEDULE

DAILY INSPECTION

Before running the engine, check the following service items.

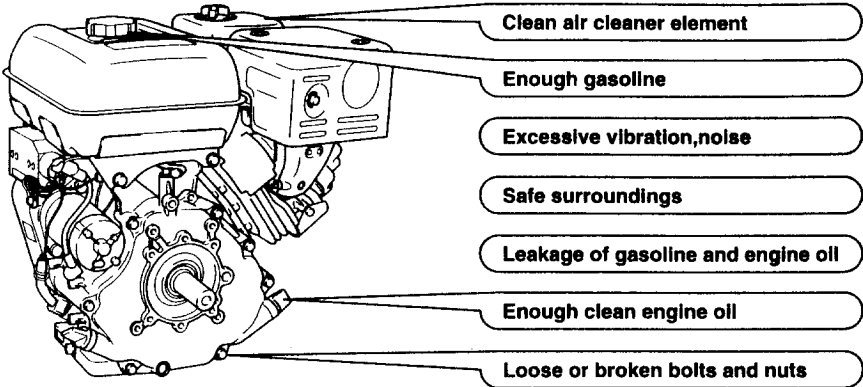

PERIODIC INSPECTION

Periodic maintenance is vital to safe and efficient operation of your engine.

Check the table below for periodic maintenance intervals.

It is also necessary for the user of this engine to conduct the maintenance and adjustments on the emission-related parts listed below to keep the emission control system effective.

The emission control system consists of the following parts :

- | | | |
|---|------------------|-------------------|
| (1) Carburetor and internal parts | (2) Choke system | (3) Fuel strainer |
| (4) Air cleaner elements | (5) Intake pipe | (6) Spark plug |
| (7) Magneto | | |
| (8) Fuel hoses, clamps, and sealing gaskets | | |

The maintenance schedule indicated in the following table is based on the normal engine operation.

Should the engine be operated in extremely dusty condition or in heavier loading condition, the maintenance intervals must be shortened depending on the contamination of oil, clogging of filter elements, wear of parts, and so on.

	8 hours (daily)	20 hours	50 hours (weekly)	200 hours (Monthly)	500 hours	1000 hours
CLEAN ENGINE AND CHECK BOLTS AND NUTS	● (daily)					
CHECK AND REFILL ENGINE OIL	● (Refill daily up to upper limit)					
CHANGE ENGINE OIL (*Note 1)		● (Initial)	●			
CLEAN SPARK PLUG			●			
CLEAN AIR CLEANER			●			
CLEAN FUEL STRAINER				●		
CLEAN AND ADJUST SPARK PLUG AND ELECTRODES				●		
REPLACE SPARK PLUG					●	
REMOVE CARBON FROM CYLINDER HEAD (*Note 2)					●	
ADJUST VALVE CLEARANCE (*Note 2)					●	
CLEAN AND ADJUST CARBURETOR (*Note 2)					●	
PEPLACE FUEL LINES						● (yearly)
OVERHAUL ENGINE (*Note 2)						●

*Note : 1. Initial oil change should be performed after first twenty (20) hours of operation. Thereafter change oil every fifty (50) hours.

Before changing oil, check for a suitable way to dispose of old oil.

Do not pour it down into sewage drains, onto garden soil or into open streams. Your local zoning or environmental regulations will give you more detailed instructions on proper disposal.

*Note : 2. As to the procedures for these items, please refer to the SERVICE MANUAL or consult your nearest Robin service dealer.

9. "HOW-TO" MAINTENANCE

INSPECTING THE SPARK PLUG

- Clean off carbon deposits on the spark plug electrode using a plug cleaner or wire brush.
- Check electrode gap. Adjust gap 0.03 inches. (0.7 mm to 0.8 mm)

- Use a proper spark plug :
NGK BP6ES
CHAMPION N9Y

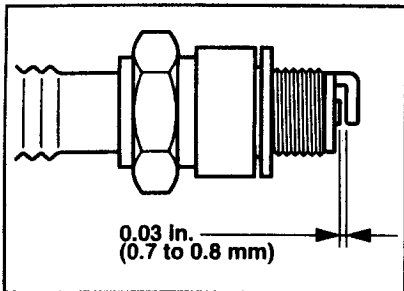

ENGINE OIL CHANGE

- Initial oil change
..... After 20 hours of operation
- Thereafter
..... Every 50 hours of operation

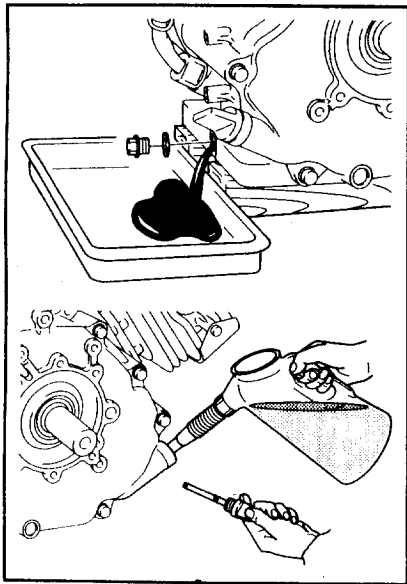

CAUTION

Make sure the fuel cap is tightly secured to avoid spillage.

1. When changing oil, stop the engine and loosen the drain plug.
2. Re-install the drain plug before refilling oil.
3. Refer to the recommended oil table on page 5.
4. Always use the best grade and clean oil. Contaminated oil, poor quality oil and shortage of oil cause damage to engine or shorten the engine life.

OIL CAPACITY :
EH36 1.2 liter
EH41 1.2 liter

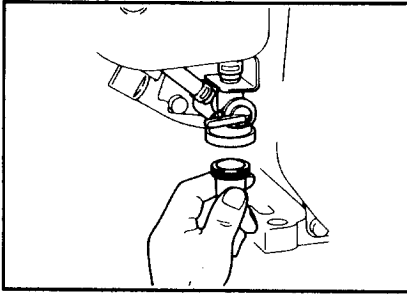

CLEANING FUEL STRAINER (NO SMOKING !)

- Inspect fuel strainer for water and dirt.
- To remove water and dirt, close the fuel cock and remove the strainer cup.
- After removing dirt and water, wash the strainer cup with gasoline. Reinstall securely to prevent leakage.

CLEANING AIR CLEANER

Dirty air cleaner element will cause starting difficulty, power loss, engine malfunctions, and shorten engine life extremely.

Keep the air cleaner element clean.

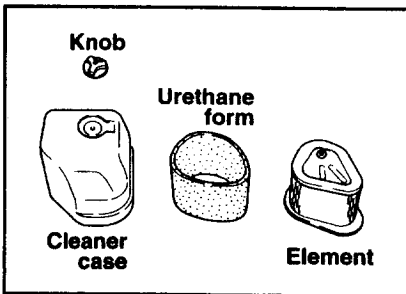

Air cleaner paper element and urethane form can be take out after removing knob and air cleaner cover.

When installing, set the paper element and urethane form on the air cleaner base. Be sure to check the grommet is in position, and then install the cover with knob tightened securely.

● Urethane Form cleaning

Wash and clean the urethane form in kerosene. Saturate in a mixture of 3 parts kerosene and 1 part engine oil, and then squeeze to remove excess oil. Clean urethane form every 50 hours.

● Paper element

Clean by tapping gently to remove dirt and blow off dust. Never use oil. Clean paper element every 50 hours of operation, and replace element every 200 hours or once a year.

- If an oil bath or special air cleaner with precleaner is used, clean the oil pan, fill oil to the required level or clean the dust pan.

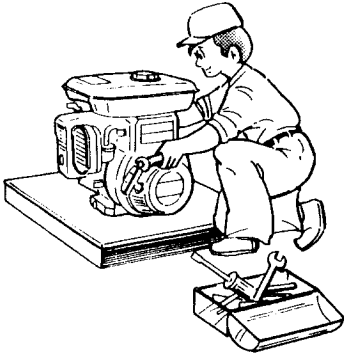

CHECKING BOLTS, NUTS AND SCREWS

Retighten loose bolts and nuts.
Check for fuel and oil leaks.
Replace damaged parts with new ones.
Keep safety in your mind.

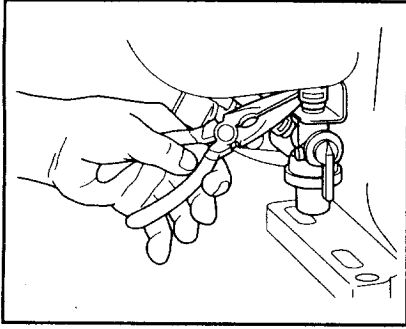

FUEL PIPE REPLACEMENT

Replace the fuel pipe every 2 years.
When fuel leak is found replace it immediately.

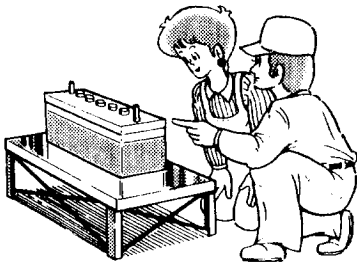

CHECK BATTERY

If the electrolyte fluid is below level line,
refill with distilled water to the upper
level line.

10. PREPARATIONS FOR STORAGE

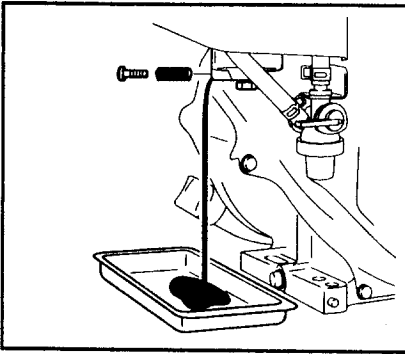

DISCHARGE FUEL (NO SMOKING !)

- Remove the strainer cup, place the strainer over a container and open the strainer cock to discharge fuel from the fuel tank.
- Remove the drain screw of the carburetor float chamber and discharge fuel.



ENGINE OIL

- Change the engine oil with fresh oil.
- Remove the spark plug, pour about 5 cc of engine oil into the cylinder, slowly pull the starter handle of the recoil starter 2 or 3 times, and re-install the spark plug.

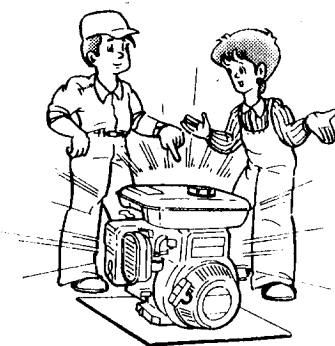

CLEAN AND STORE

- Slowly pull the recoil starter handle until resistance is felt and leave it in that position.
- Clean the engine thoroughly with an oiled cloth, put the cover on, and store the engine indoors in a well-ventilated, low humidity area.

11. SPECIFICATIONS

MODEL	EH36D	EH36B	EH41D	EH41B
Type	Air-cooled, 4-cycle single cylinder, horizontal shaft, gasoline engine			
Displacement	404 cm ³			
Continuous Output	6.3 kW/3600 min ⁻¹ (8.5 HP/3600 rpm)	6.3 kW/1800 min ⁻¹ (8.5 HP/1800 rpm)	7.0 kW/3600 min ⁻¹ (9.5 HP/3600 rpm)	7.0 kW/1800 min ⁻¹ (9.5 HP/1800 rpm)
	5.5 kW/3000 min ⁻¹ (7.5 HP/3000 rpm)	5.5 kW/1500 min ⁻¹ (7.5 HP/1500 rpm)	6.3 kW/3000 min ⁻¹ (8.5 HP/3000 rpm)	6.3 kW/1500 min ⁻¹ (8.5 HP/1500 rpm)
Maximum Output	8.5 kW/3600 min ⁻¹ (11.5 HP/3600 rpm)	8.5 kW/1800 min ⁻¹ (11.5 HP/1800 rpm)	9.9 kW/3600 min ⁻¹ (13.5 HP/3600 rpm)	9.9 kW/1800 min ⁻¹ (13.5 HP/1800 rpm)
Direction of Rotation	Counterclockwise, as Viewed from P.T.O. Shaft side			
Lubricant	Class SE, SF or higher grade, SAE #20, #30, #40 or multi-grade engine oil			
Fuel	Automobile Gasoline (unleaded)			
Fuel Tank Capacity	7.0 liters			
Spark Plug	NGK BP6ES (CHAMPION N9Y)			
Starting System	Recoil starter (Electric starter available as option)			
Dry Weight	31 kg	32 kg	31 kg	32 kg
Dimensions	Length	389 mm		
	Width	431 mm		
	Height	443 mm		







 **FUJI HEAVY INDUSTRIES LTD.**

INDUSTRIAL PRODUCTS DIV.

2nd, Subaru Bldg.

1-1, Miyahara-cho, Omiya-shi,
Saitama 330-0038, Japan

PHONE : (OMIYA 48) 653-5811

FACSIMILE : (OMIYA 48) 653-5691

PRINTED IN JAPAN
May 1998 CE-Ⓢ